



**Poseidon House
Castle Park
Cambridge CB3 0RD
United Kingdom**

TELEPHONE:
INTERNATIONAL:
FAX:
E-MAIL:

**Cambridge (0223) 323010
+44 223 323010
+44 223 359779
apm@ansa.co.uk**

APM Business Unit

Data Communications and Distributed Computing

Owen Rees

Abstract

A presentation to the BRAIN Second International Summer School on Advanced Broadband Communications (ABC) held in Madrid and Aveiro, 11-15 July 1994. The abstract was:

“This talk will address the use of the Open Distributed Processing (ODP) Basic Reference Model to support the development of Virtual Private Networks. It will discuss ongoing work in the ANSA project on dependability and federation, and explain the relevance of the Object Management Group (OMG) CORBA architecture in the modelling, design, and deployment of intelligent network services.”

Customer demand for tailored services, delivered quickly at a competitive price is putting pressure on communication service providers. Virtual Private Networks are one such service.

Adding new facilities to the large and complex communication network which must remain operational is a difficult technical problem, and has, in the past, taken more time than is now acceptable to customers.

Techniques developed to address the same issues for Open Distributed Processing can be adopted to help to solve this problem

APM.1264.00.04

Draft
External Paper

23 June 1994

Distribution:

Supersedes:

Superseded by:



Data Communications and Distributed Computing

Owen Rees

ANSA Team

APM Ltd.

Poseidon House, Castle Park

Cambridge, CB3 0RD, UK

rtor@ansa.co.uk

<http://www.ansa.co.uk/>



Overview

- ***Common factors in Data Communication and Distributed Computing***
 - Customer demands
 - Technology trends
 - Value is in services, not physical items
- ***The Distributed Computing Approach***
 - Managing complexity
- ***Virtual Private Networks***
 - An example of a service
 - Apply the distributed computing approach



Meet the customer's needs

- **timely:** *I want it NOW! (well, yesterday)*
- **personalised:** *I want it just the way I like it!*
- **competitive:** *I don't want to pay over the odds!*
- **dependably predictable:** *It should be there when I need it!*
- **integratable:** *Why can't I connect it to my PABX, PC, ...?*

..... before your competitor does

The business challenge

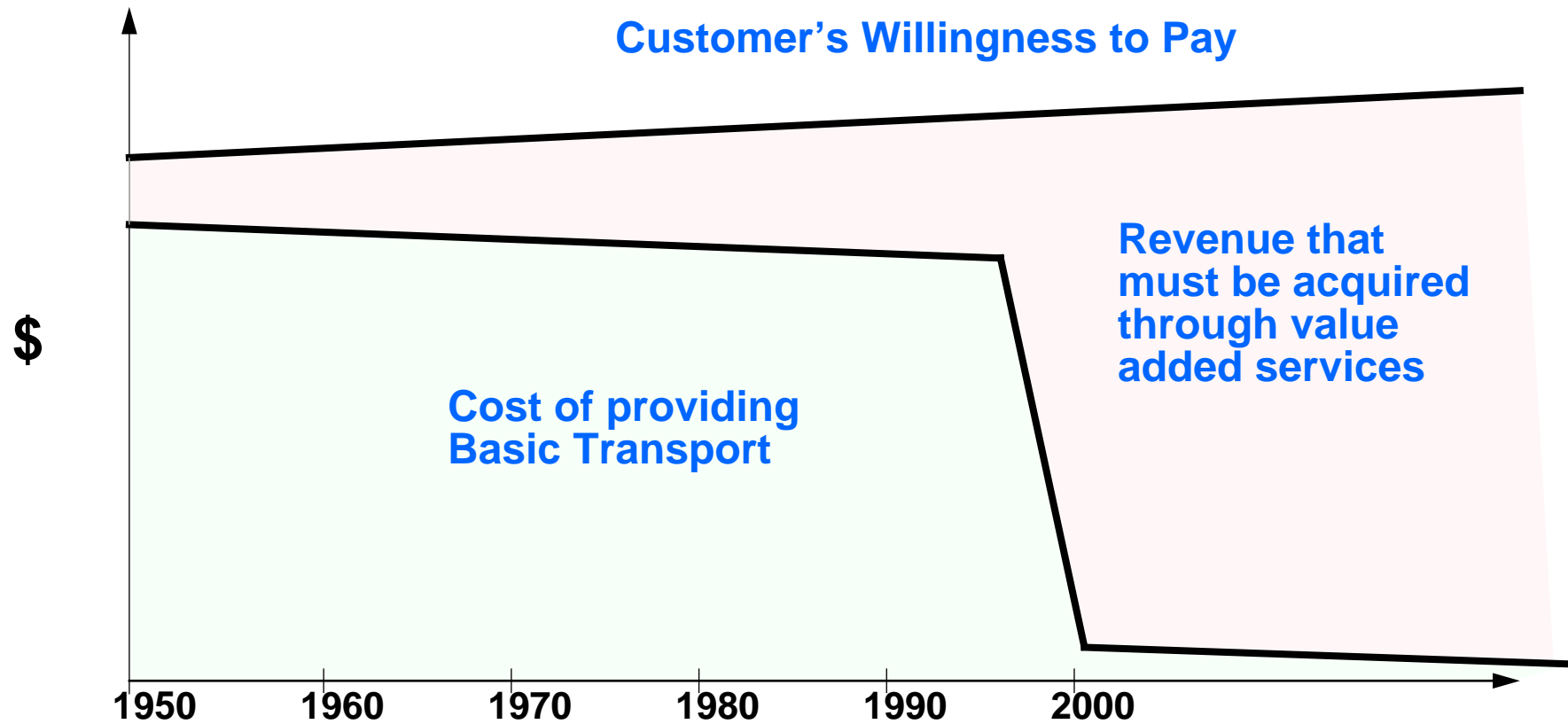

Software cost

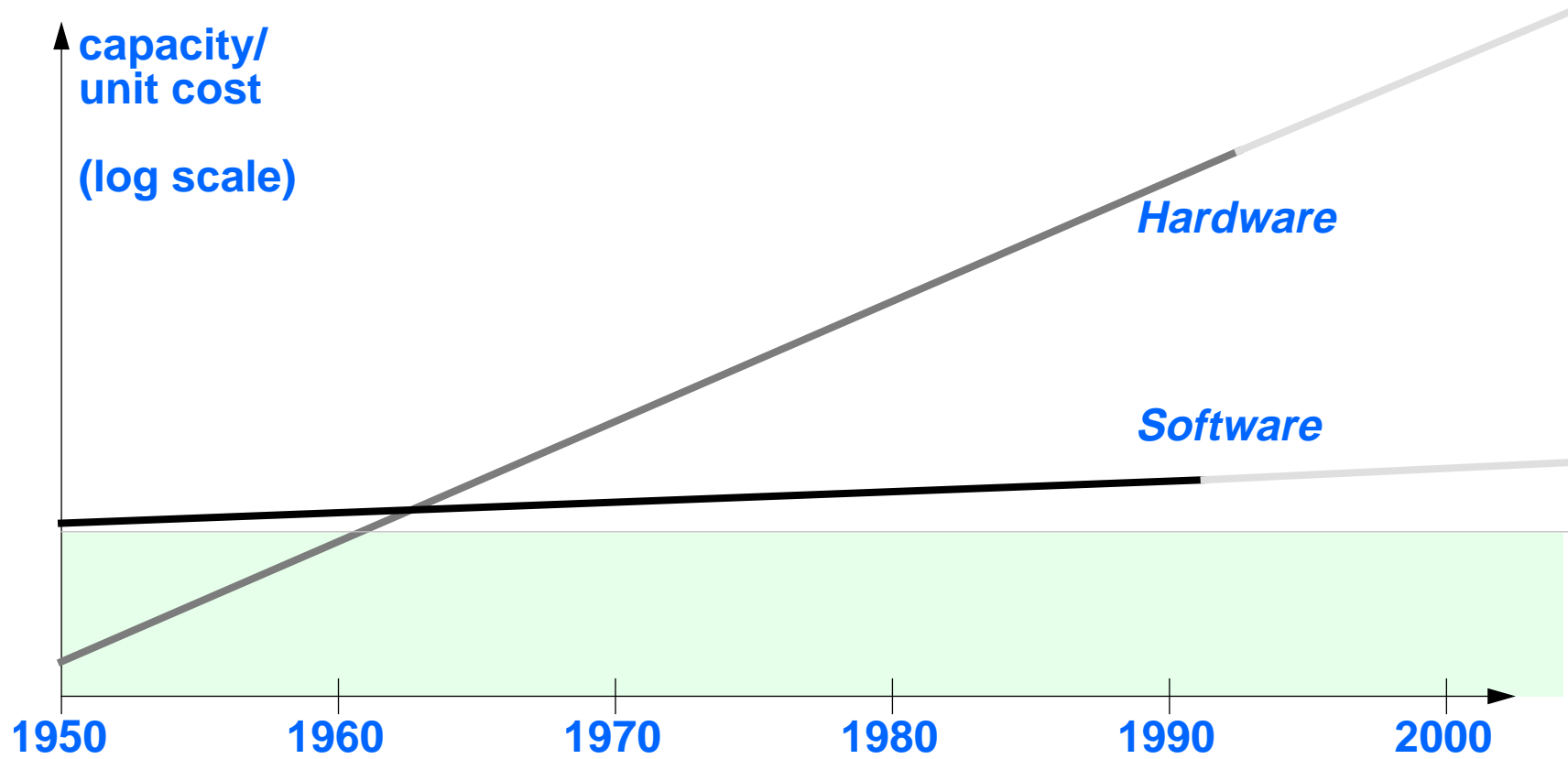



Providing Services – a New Problem?

- *Project management*
- *Requirement analysis*
- *Analysis and design methodologies*
- *Informal and formal approaches*

No, but solutions do not **SCALE** very well



The Service Provider's Problem

- **Providing networked information services**
 - not physical
- **Critical Success Factors**
 - services can be *developed rapidly*, to meet market windows
 - new services can *interwork* with existing services
 - services are *easy to deploy*
 - services are *easy to manage*
- **Meet the customer's needs**
 - before your competitors
 - at a price the customer will pay



Distributed Computing Approach

- *Enable information services*
- *Tools and components for information service providers*

The Strategy

- *Object-based*
 - separation
 - substitutability
- *Architecture*
 - managing complexity

..... does this apply to Data Communication

System Structure: Separation

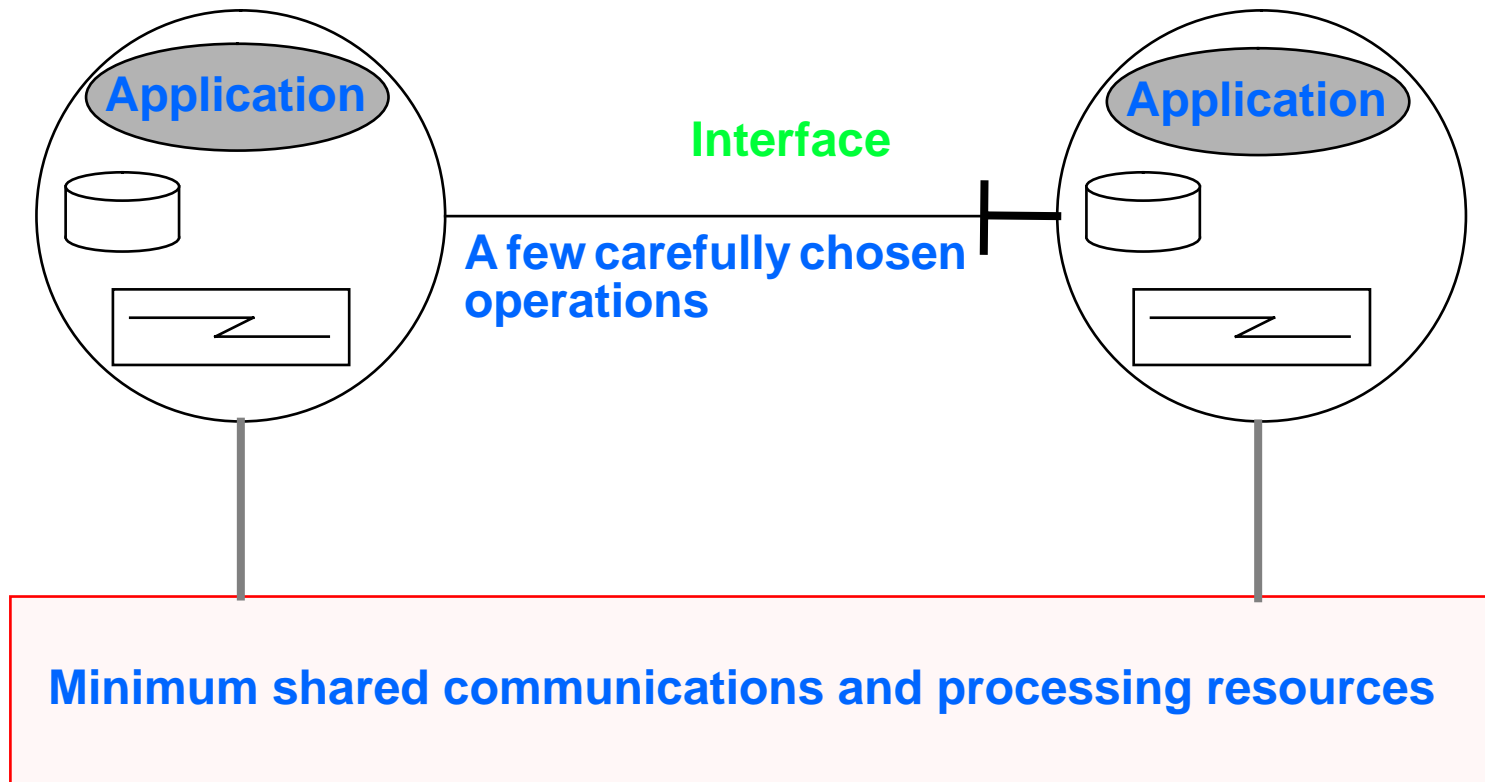

Operational Interfaces

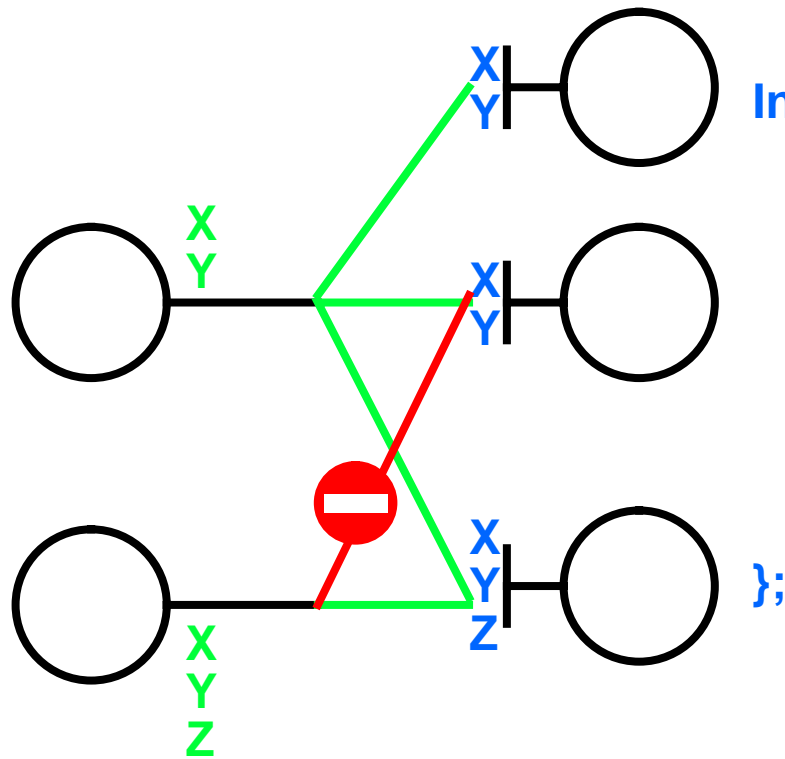

Interface {
 operation₁ (< typed parameter >)
 -> outcome₁ (< typed result >)
 ⋮
 -> outcome_n (< typed result >);
 ⋮
 operation_n (< typed parameter >)
 -> outcome₁ (< typed result >)
 ⋮
 -> outcome_n (< typed result >)
 };

Stream Interfaces

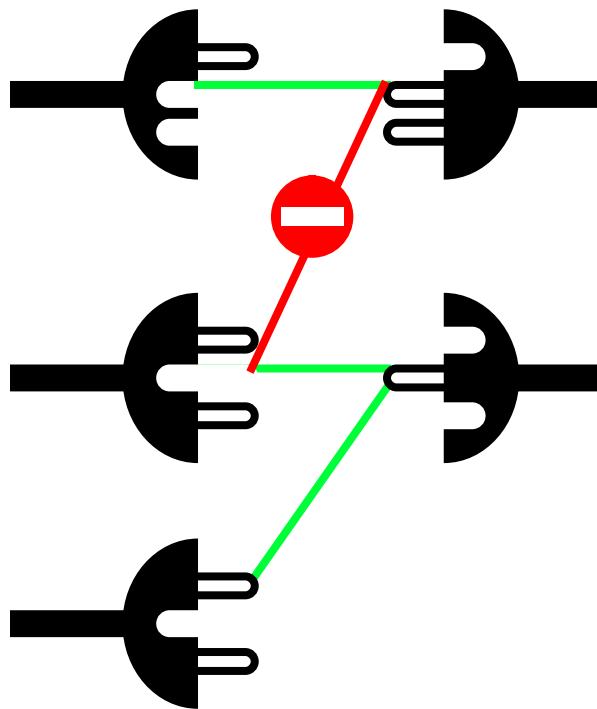

- ***Stream interfaces***
 - a set of flows
 - each flow has a direction and “type”
 - for computationally unstructured streams of information
 - audio, video, telemetry
 - for information streams with “irrelevant” structures
- ***Distributed computing interest in streams***
 - compatibility (conformance)
 - flow direction and type
 - control
 - connect (bind), start, stop

Component description

- *by the process which created them*
- *or as components in their own right*

purpose: *what is it for?*

meaning: *how may it be used?*

structure: *what components does it need or consist of?*

guarantees: *what promises will be kept?*

technology: *what technologies are necessary?*

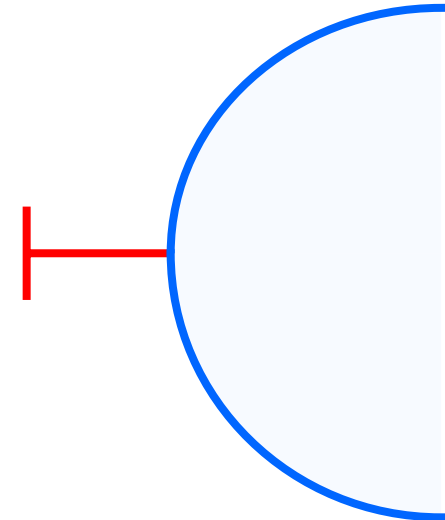

Architecture

Basic building blocks

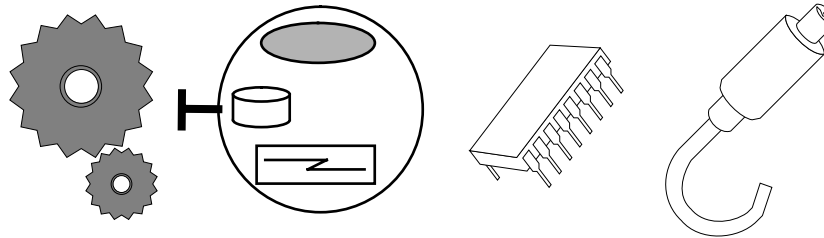

Combination rules

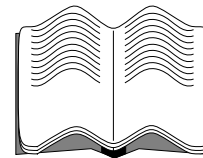
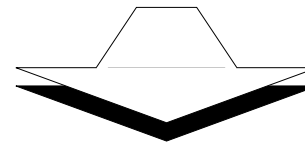
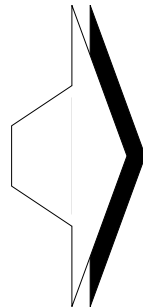
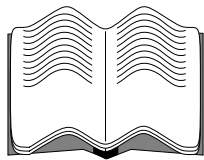

Recipes

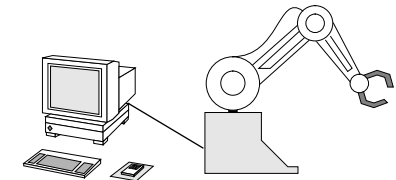
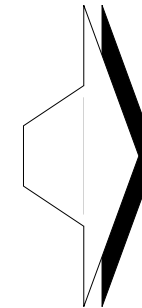

Architecture is about structure

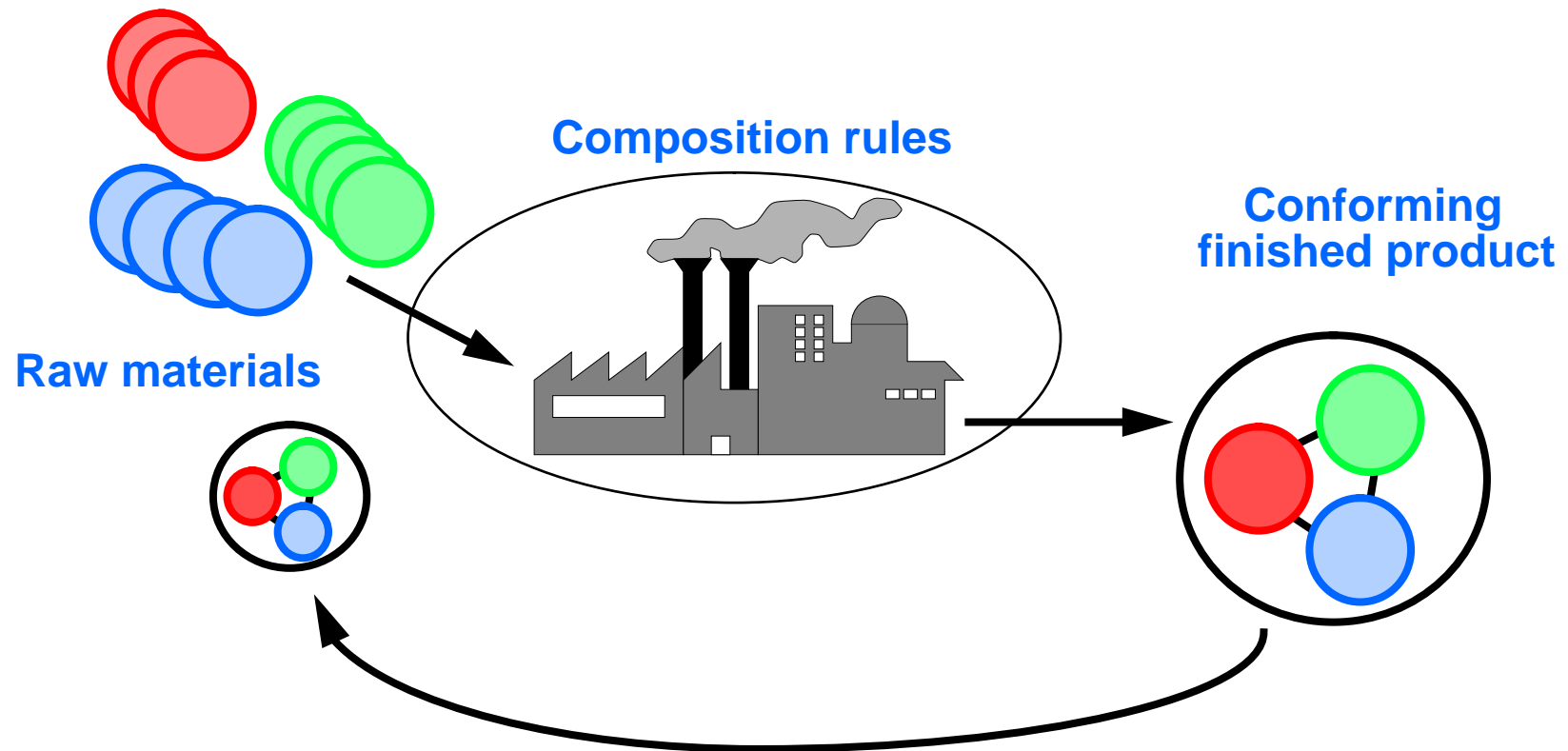

Access to descriptions

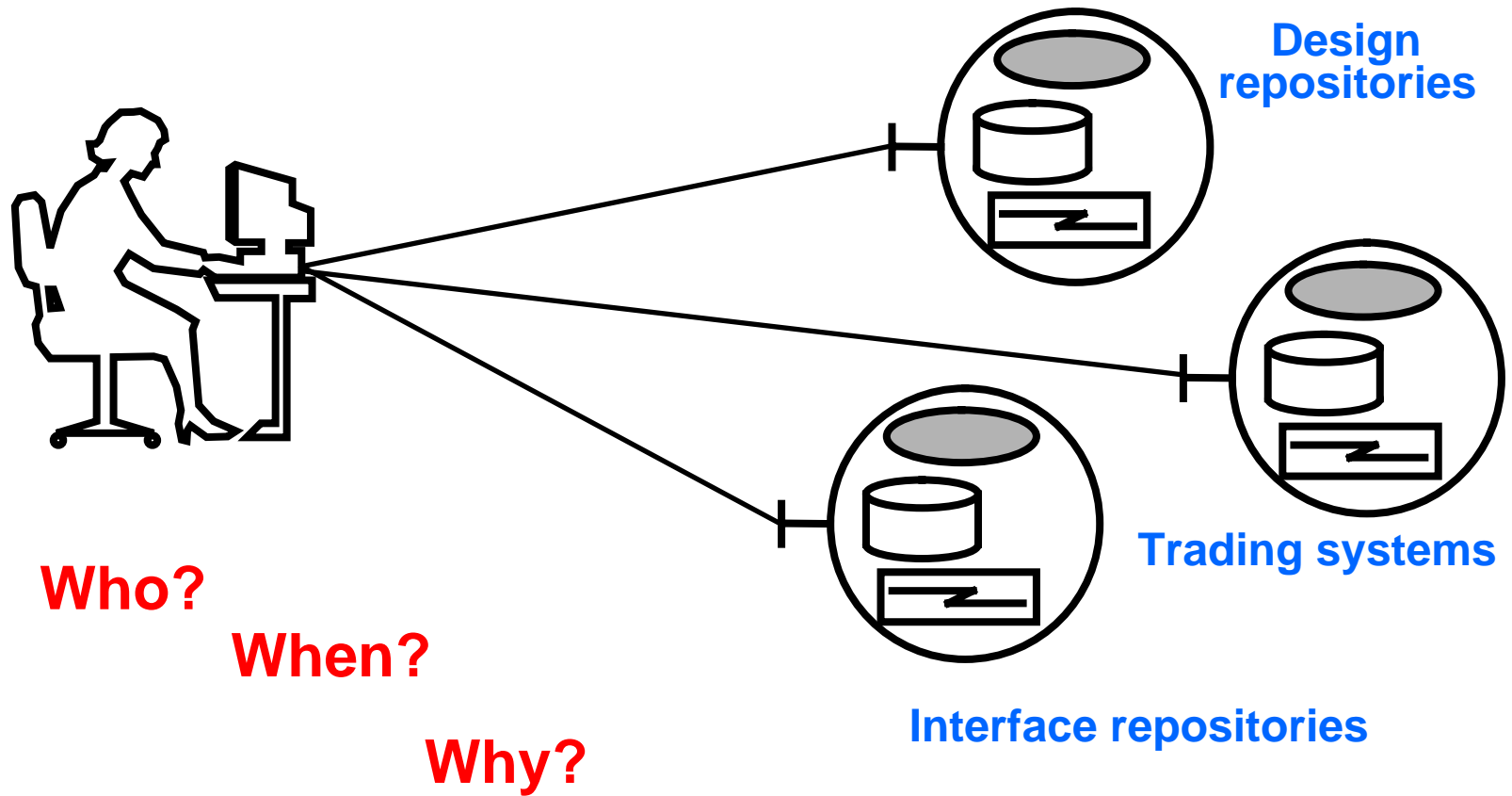



Distributed Object Approach

- *The business model driving the computer industry*
 - application integration
 - right-sizing
 - collaborations for specific projects
- *Distributed objects are being adopted as the solution*
- *Standards*
 - ISO/IEC, ITU-T – Basic Reference Model of Open Distributed Processing
 - OMG – Common Object Request Broker Architecture
- *Technology – available now*
- *Separation, substitutability – define the Services*
- *Descriptions – make them available*



An Example – Virtual Private Network

- *What is it*
- *Who wants it*
- *Who provides it*
- *How can the Distributed Computing approach be used*



What is a Virtual Private Network (VPN)?

- ***Public network resources – private network capabilities***
 - No private equipment needed; **no need to BUY** equipment, but
 - Must interwork with **existing** customer equipment
 - Connect different sites, big office with PABX, small office without PABX
- ***First introduced for large business customers in 1985***
 - Now available to medium/small customers
 - revenue per customer is smaller, but more customers
 - provisioning, administration, management must be cheap
- ***Offer integrated voice and data, video, multi-media***
 - Visit Head Office Showroom by Virtual Reality over VPN – available 199?
- ***A target for Intelligent Network Capability Set 1 (IN CS-1)***



Who is involved

- ***Users – use private network capabilities***
 - private numbering, speed dialling, call transfer
 - do not care it is VPN – may not know
- ***Customers – subscribe to VPN services***
 - instead of buying private equipment, e.g. PABX, leased lines
 - cheaper, quicker to install, maintenance and upgrade included in service
- ***Service providers – provide the VPN services***
 - Service Control
- ***Network operators – provide the underlying network***
 - Service Switching
 - Call Control

IN Distributed Functional Plane Architecture

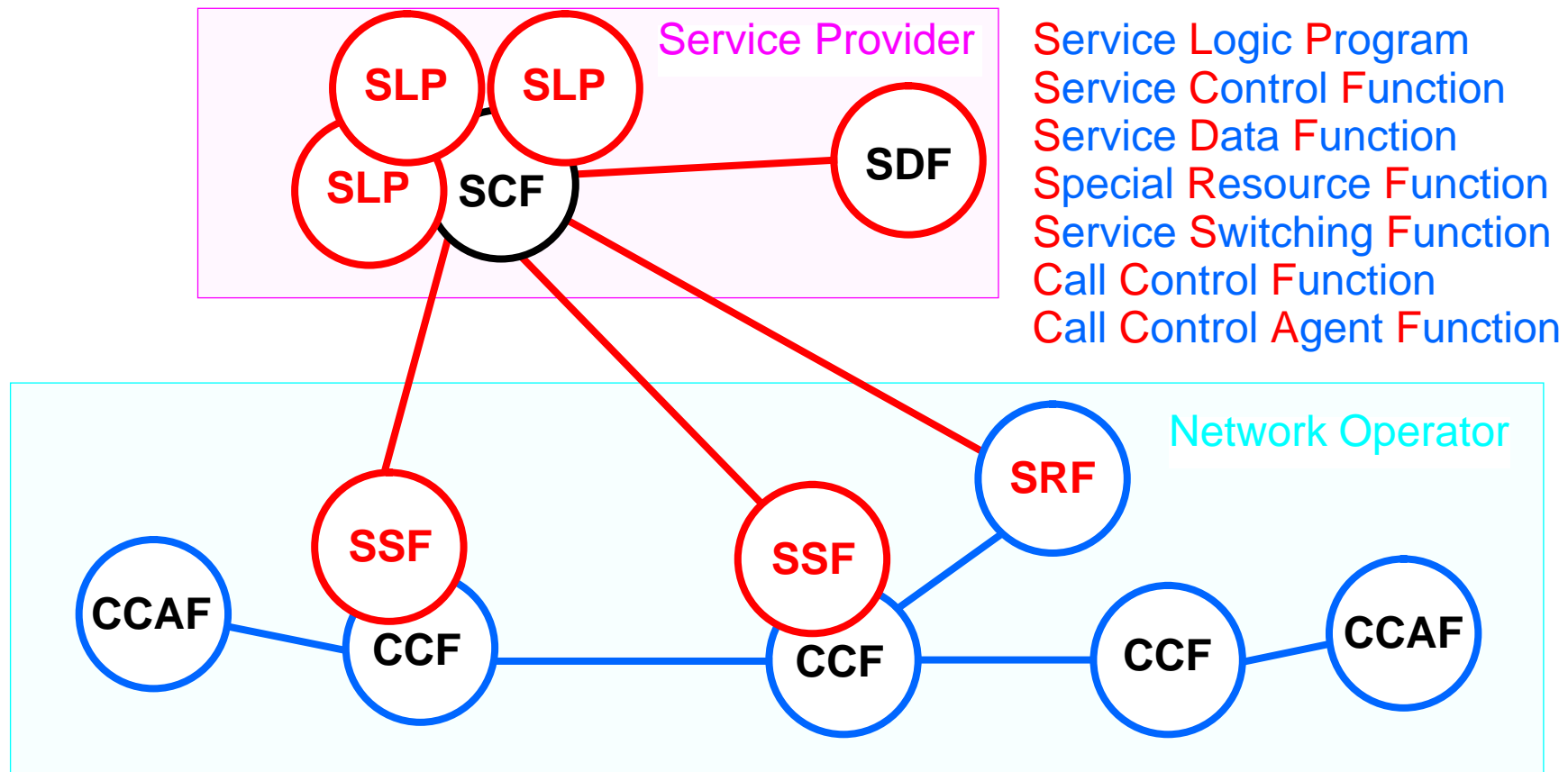

Apply Separation Principle

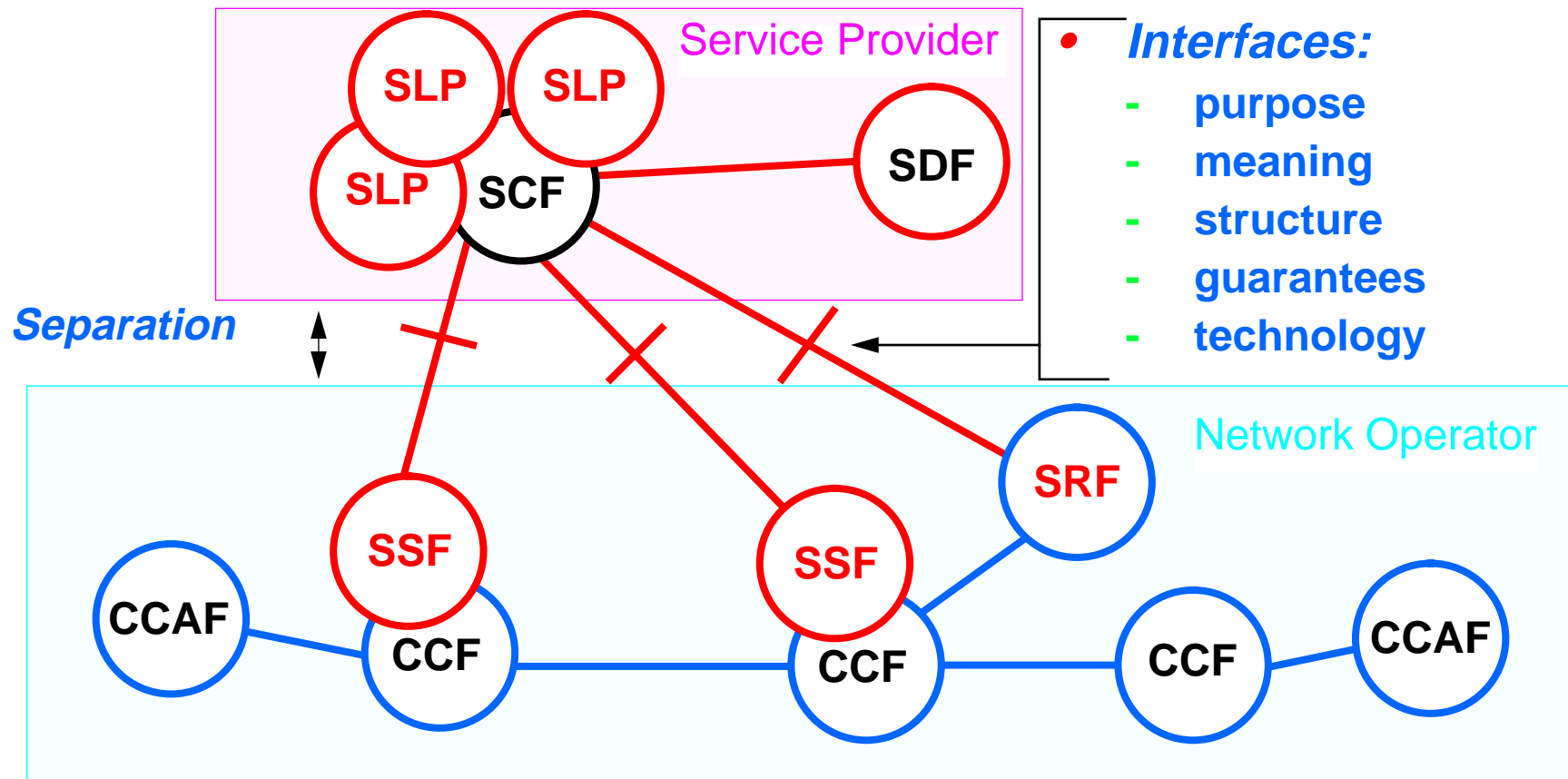

Substitutability

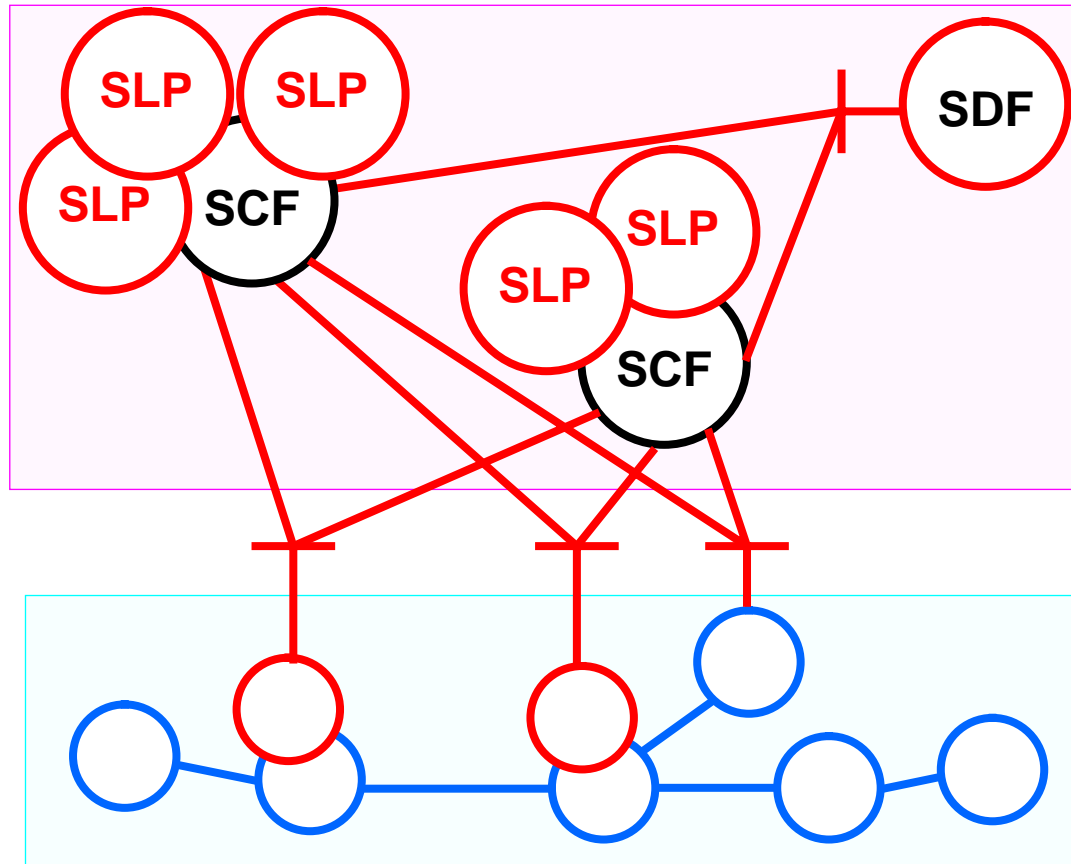

- **Choice of structure**
 - SCF per Service?
 - SCF per Feature?
- **Add new feature**
 - re-use components
 - identify interactions
- **Satisfy customer**
 - quickly
 - cheaply

Use Distributed Computing Technology

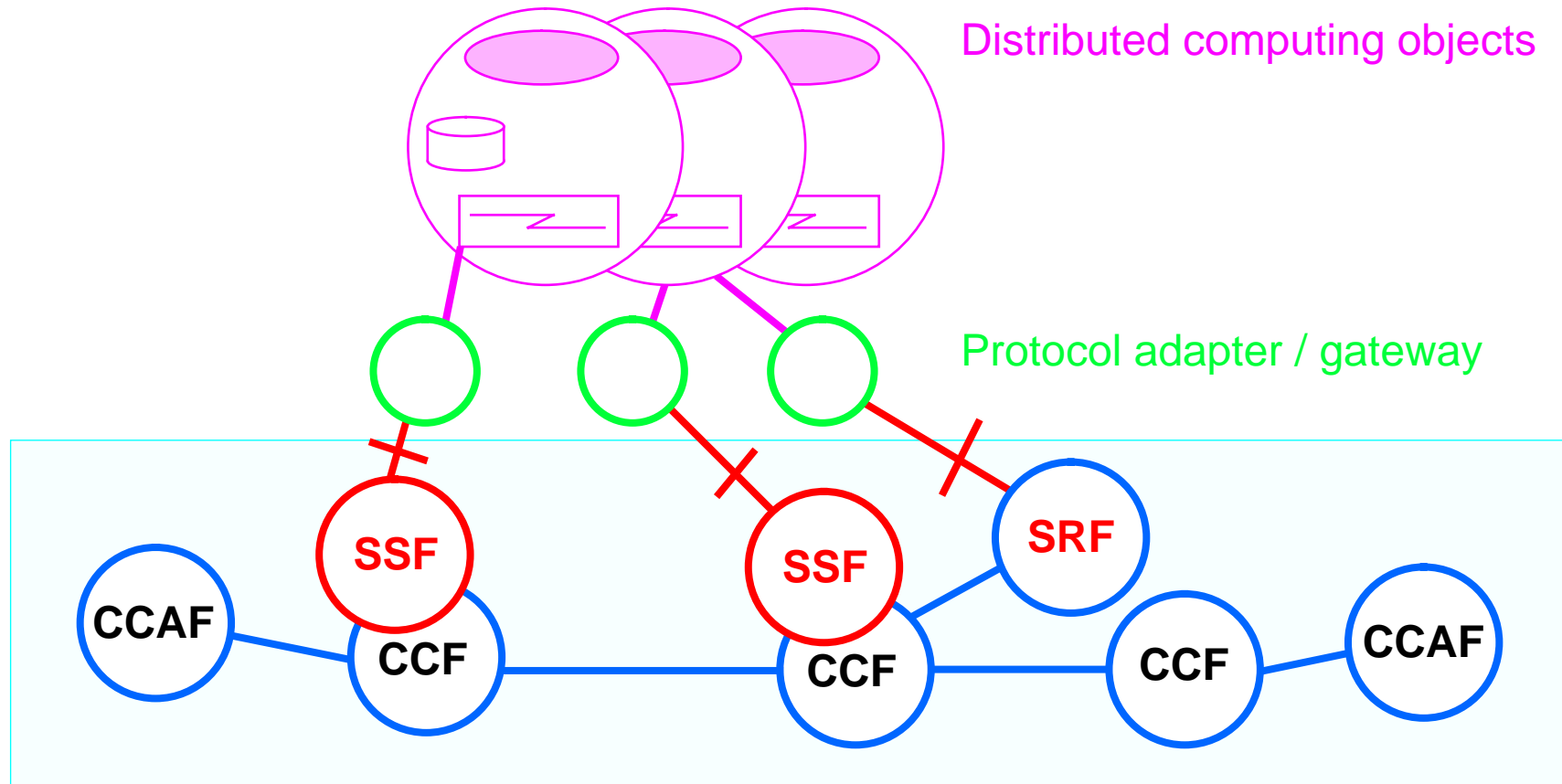



Delivering the Guarantees

- *Timeliness*
 - Real time distributed computing
- *Dependability*
 - Fault tolerant distributed computing
- *Work is in progress on these*
 - ANSA Phase 3
 - research projects, e.g. PDCS2, BROADCAST (both ESPRIT)



Summary

- ***Common factors in Data Communication and Distributed Computing***
 - Customer demands
 - Technology trends
 - Value is in services
- ***The Distributed Computing Approach***
 - Object-based distributed processing
 - Separation and substitutability
 - Architecture
- ***Approach can be applied to Data Communication***
- ***Distributed Computing Technology can be used***
 - ANSA Phase 3, and others, working on the guarantees