



---

**Poseidon House  
Castle Park  
Cambridge CB3 0RD  
United Kingdom**

TELEPHONE:  
INTERNATIONAL:  
FAX:  
E-MAIL:

**Cambridge (01223) 515010  
+44 1223 515010  
+44 1223 359779  
apm@ansa.co.uk**

---

## **Training**

# **ANSAwise - The Engineering Model**

**Chris Mayers**

### **Abstract**

Organizations wishing to understand how to design and build distributed systems need to appreciate engineering concepts to enable them to make trade-offs in these systems.

This module of the ANSAwise training programme describes the ANSA/ODP Engineering Model, covering each construct and concept briefly, from the top down. It compares and contrasts it with the Computational Model.

It does not describe applications of these features; these are covered in other modules of the training programme. Similar, quality-of-service issues (for example, performance) are not covered here.

---

APM.1351.01.03

**Draft**

14th February 1996

Briefing Note

---

**Distribution:**

**Supersedes:**

**Superseded by:**



# The Engineering Model

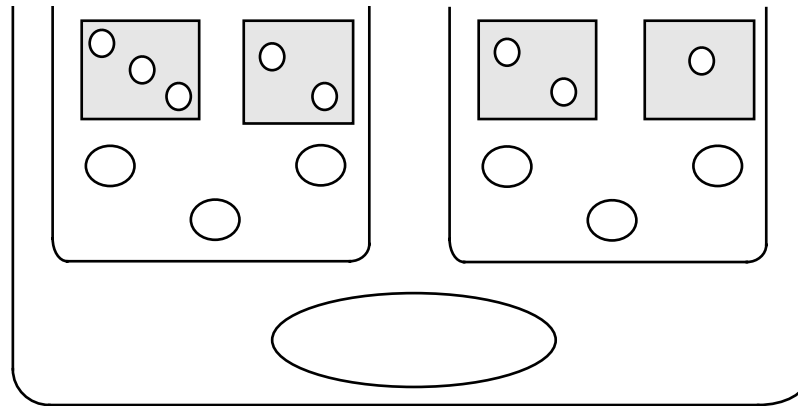



## In this session

- *Explain the concepts in the Engineering Model*
- *Explain the various types of transparency mechanisms*
- *Compare the Engineering and Computational Models*



## What is the Engineering Model for?

- *To allow trade-offs*
  - flexibility versus performance
  - time versus space
  - ... and many others
- **But without affecting the Computational Model**



---

## Engineering is infrastructure

- ***Provides infrastructure for encapsulation***
  - ***capsules*** for resource allocation and protection
  - ***clusters*** for collective activation, deactivation, and migration
  - ***nodes*** for network addressing
- ***Provides channels for communication***
  - **point-to-point** (simple client-server)
  - **point-to-multipoint**
  - **streams**
- ***Provides concurrency mechanisms***
  - ***threads*** for concurrent execution
- ***Provides transparency mechanisms***



# Engineering Encapsulation Infrastructure

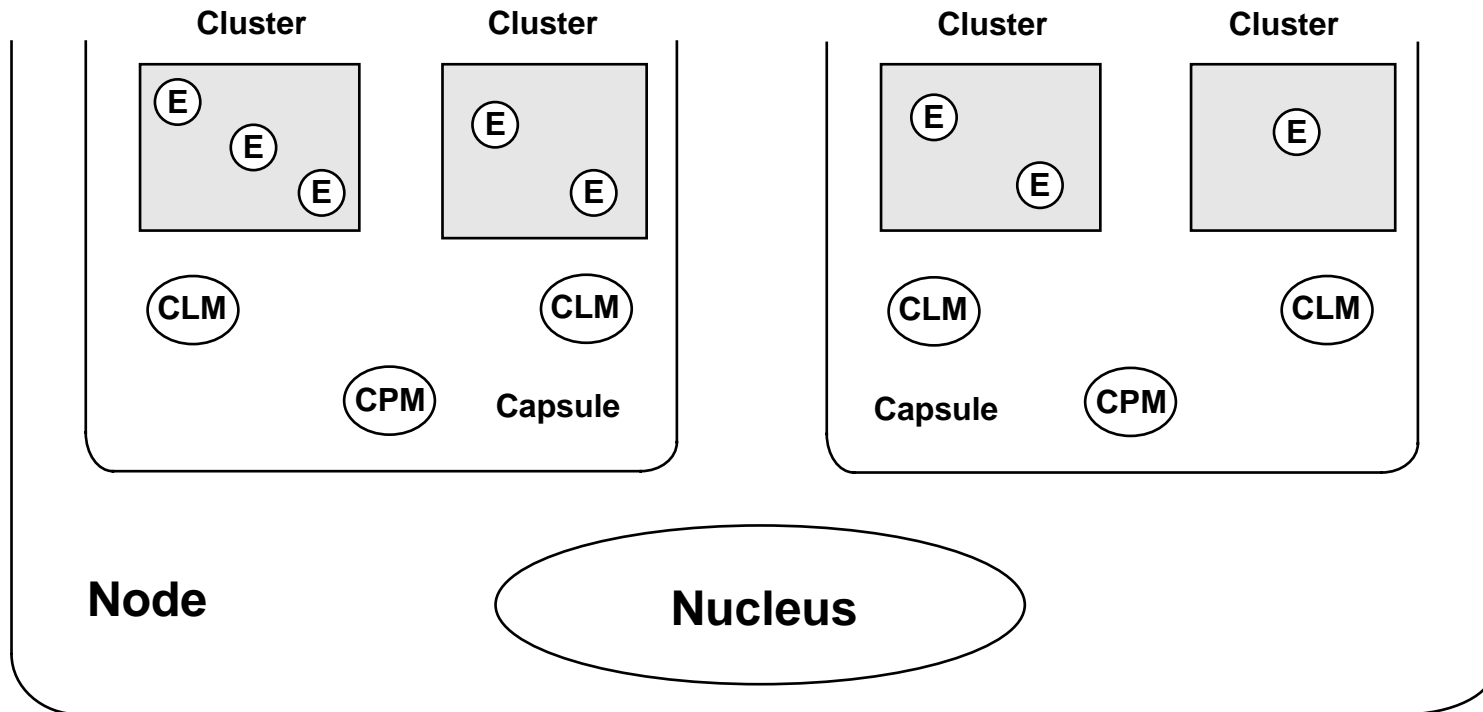

## Node and Nucleus

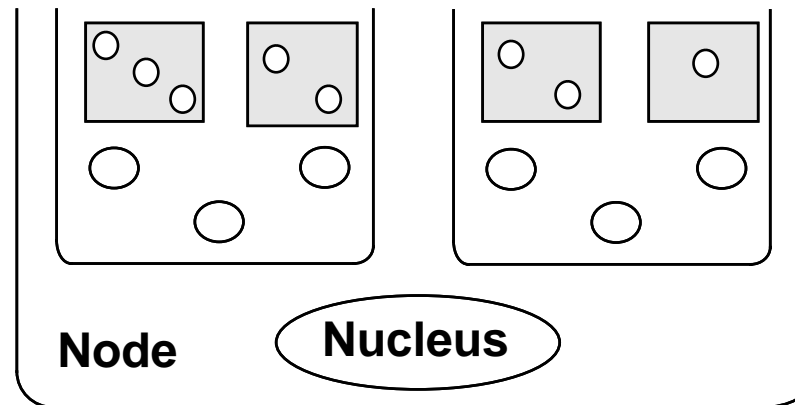

- *A node is the unit of network addressing*
- *The nucleus handles communications between nodes and capsules*
  - *it may be part of the operating system (if there is one), or a layer on top of it*



## Capsules

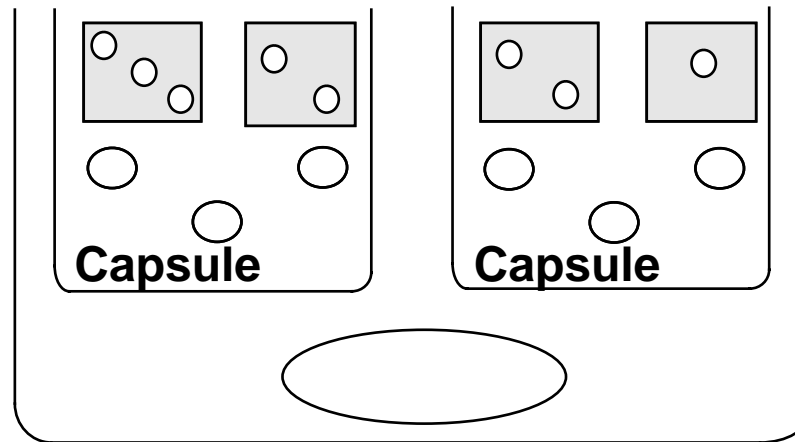

- ***Capsules contain objects***
  - **objects must be encapsulated**
  - **every object is contained in a capsule**
  - **different capsules separate the objects**



## Capsules can contain more than one object

- *Objects of the same type, or of different types*
- *Put more than one object in a capsule to*
  - *share resources*
  - *share state information*



## Capsules and Shared Memory

- *In a distributed system, two objects cannot usually share memory*
  - the objects could be distributed anywhere in the world!
  - but if particular objects do, their implementation may be more efficient
  - ... for example, you might keep objects of the same type together in the same capsule
- *Objects in the same capsule can share memory for efficiency - but then there is no protection boundary between them*
  - resources: they compete for the same resources (physical and virtual memory)
  - robustness: object failure within the capsule can cause the whole capsule to fail
  - security: there is no security between objects in the same capsule
- *Sharing memory between different capsules is not permitted*



## Capsules and Objects

- *So, the Computational and Engineering Models of an object are different:*
  - in the Computational Model, every object is separately encapsulated; objects cannot share state
  - in the Engineering Model, objects can share a capsule, and share state



## Capsules and Interfaces

- *Objects in the same capsule can still invoke each other's interfaces*
  - you are not compelled to use shared memory within a capsule
- *Object interfaces are invoked in the same way...*
  - within a capsule
  - between two capsules on the same node
  - between two nodes
- *...the infrastructure will optimize communications between objects on the same node*



## Nodes and Capsules

- *Most systems can support more than one capsule per node*
  - using the multi-tasking and memory protection features of the operating system
  - Unix can...
  - ...DOS can't (only one capsule per node)

## Clusters

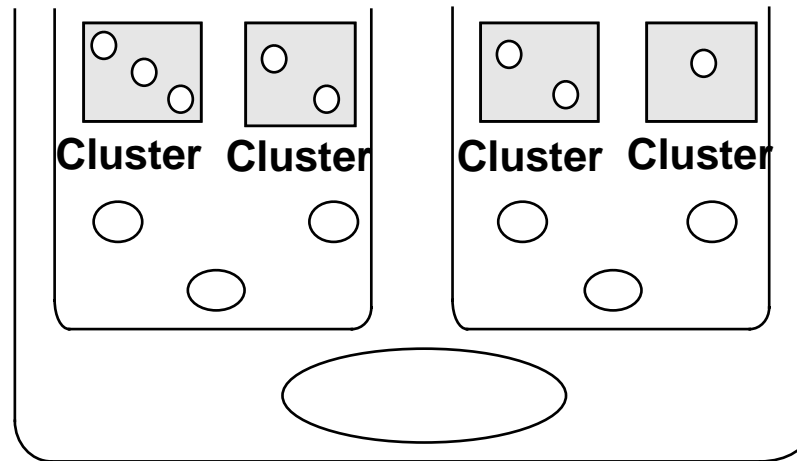

- ***A cluster is a collection of objects that must be 'kept together'***
  - **if an object moves (*migrates*) between capsules, objects that share memory must move together with that object**
  - **if an object fails, you might want to shut down other objects automatically**
  - **when starting up one object, you might want to start up other objects automatically**



## Clusters and Capsules

- *A capsule can support multiple clusters*
- *A Cluster Manager handles this for each cluster*
  - *it coordinates checkpoints for the cluster (snapshots of its state)*
- *If there are no clusters, no Cluster Manager is needed*





## Channels

- ***Channels are communication paths between objects***
- ***Channels may be:***
  - 1 to 1 (point-to-point)
  - 1 to many (point-to-multipoint)
- ***Channels may be:***
  - operational
  - stream
- ***Channels are layered:***
  - built from *stubs, binders, and protocol objects*
  - there may be multiple protocols in a particular infrastructure...
  - ...layering hides the diversity from the application

## Point-to-Point Client-Server Channel

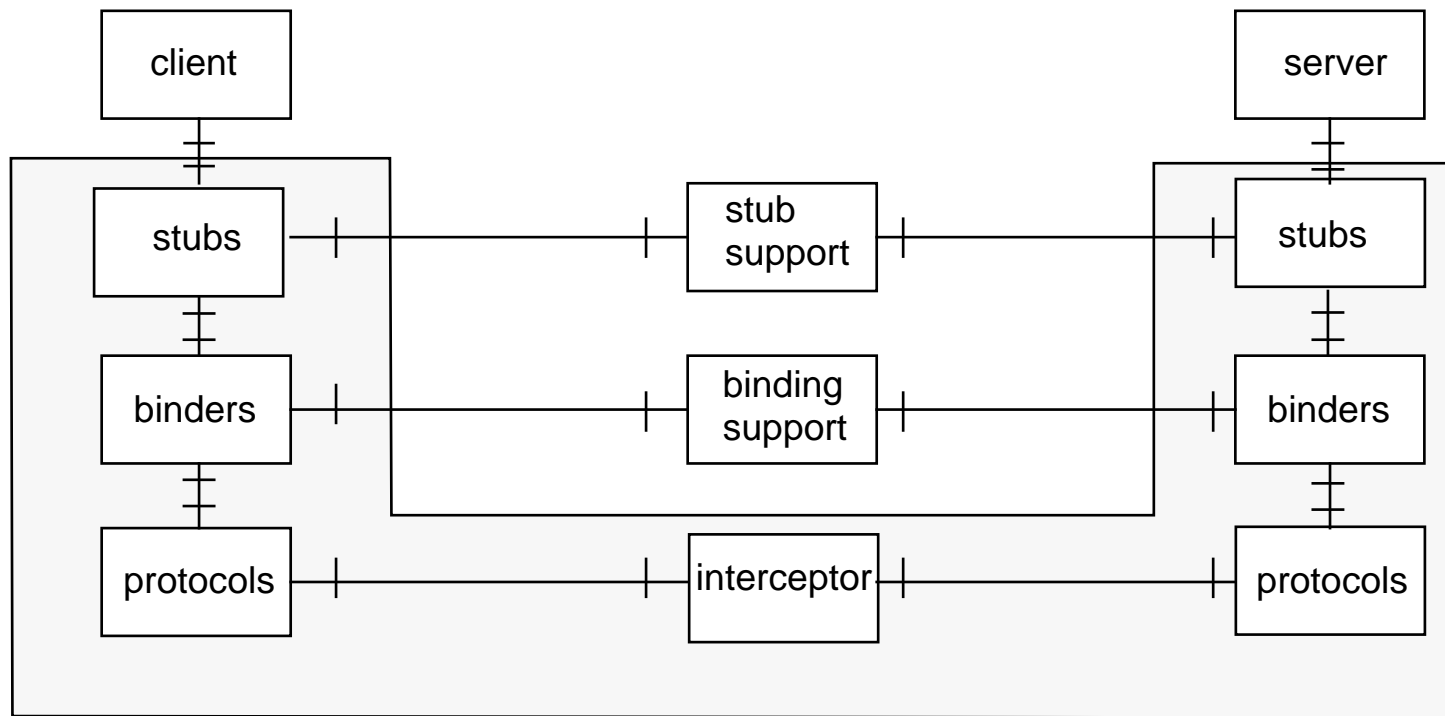



## Stubs, Binders, and Protocol Objects

- *Stubs provide data conversion*
- *Binders manage end-to-end integrity and quality-of-service*
- *Protocol objects provide communication*
- *... Most application developers will only be aware of stubs*
  - *and even these will probably be generated automatically*



## Concurrency

- *Capsules on the same node run concurrently*
- *Within a capsule, you can use threads to achieve concurrency*
  - *these may be supported by the operating system, or by the nucleus*
  - *... threads are always available, even under DOS!*
- *On a multi-processor system, different threads in the same capsule can run simultaneously on different CPUs*



## Transparencies - Simplifying distribution

- ***Remember that in a distributed system, traditional design assumptions must be reversed***
  - for example, mobility: objects do not stay in one place, they can migrate
- ***Must isolate the specification of transparencies from their design***
  - Computational Model just assumes the transparencies are provided when needed
  - Engineering Model must show how transparencies are provided from engineering mechanisms
- ***Applications developers simply state which transparencies they require***
  - software tools construct them automatically from the engineering mechanisms

## Transparency examples

- *In these examples the diagrams are slightly simplified*
- *This shows an object invoking an operation from another capsule*

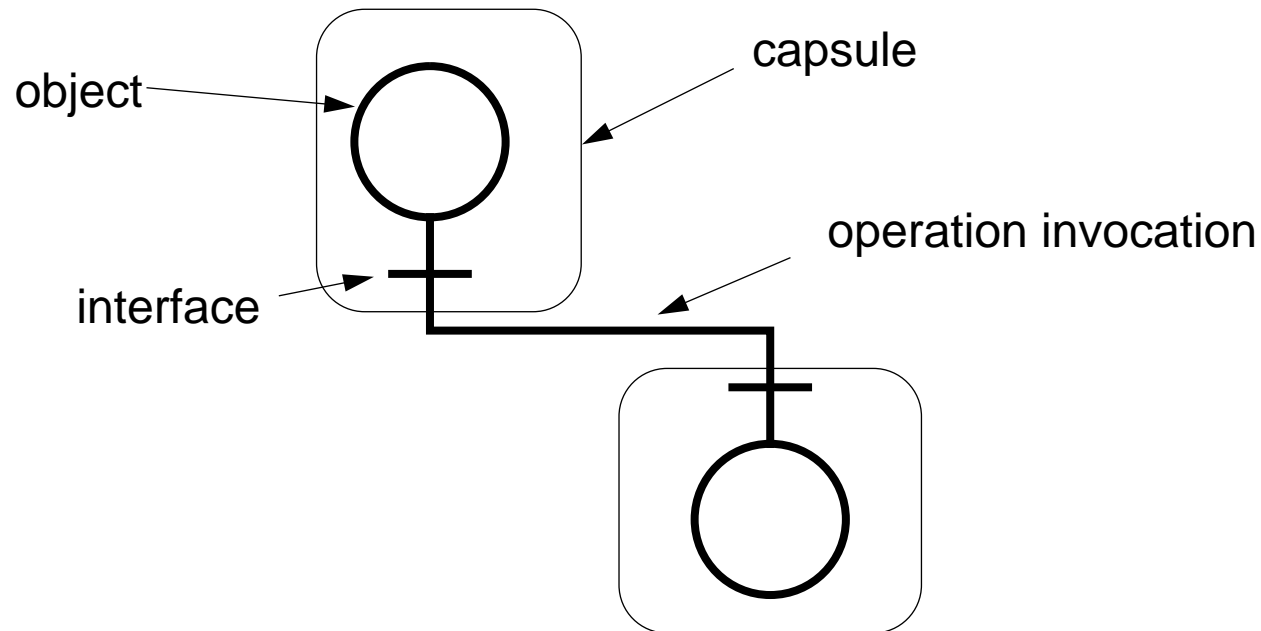

## Selective Transparency Engineering - Location

- Location Transparency
  - application need not know where object is to use it

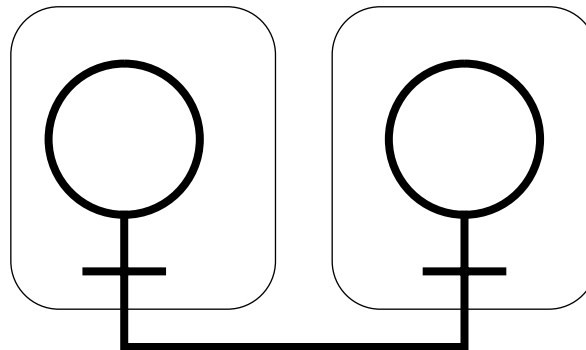

- objects may be in the same capsule, different capsules, or different nodes

## Selective Transparency Engineering - Access

- **Access Transparency**
  - application need not know the type of machine where the object is executing

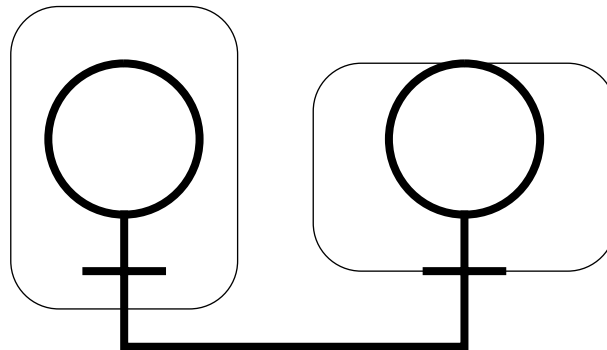

- objects may be in capsules on different operating systems, on different processor types (mainframe, workstation, or PC),...



## Selective Transparency Engineering - Migration

- Migration Transparency
  - application need not know where the object has moved to

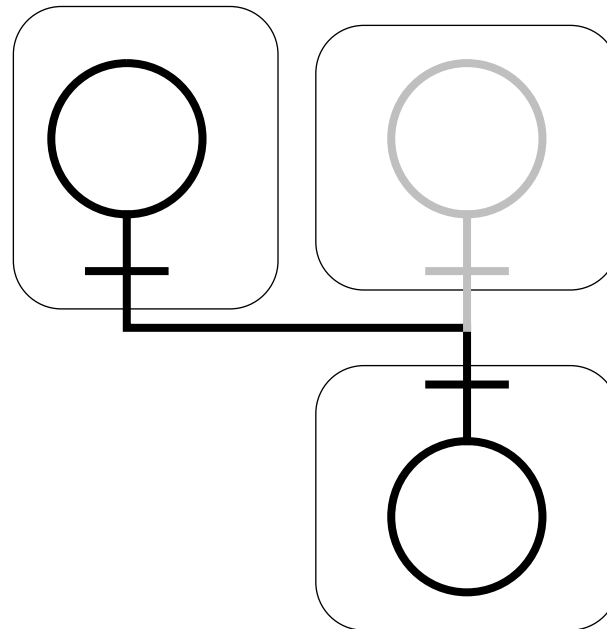



## Migration Transparency

- ***Object migration needed:***
  - when a node fails, and its capsules have to be moved to another node
  - for load-balancing between capsules
- ***Like a stronger form of location transparency***
  - relies on location transparency mechanism

## Selective Transparency Engineering - Federation

- Federation Transparency
  - application need not know where administration boundaries are

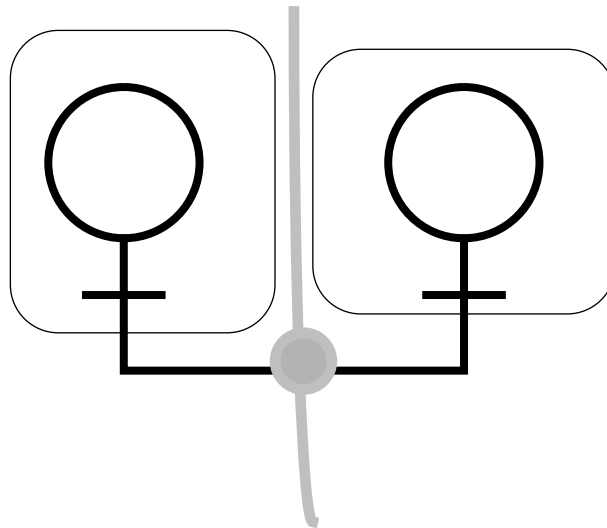

- interception may happen at the boundary, but this is not visible to the application



## Federation Transparency

- ***Federation is an Enterprise issue***
  - **there are many different kinds of federation boundaries: administration, organizational, contractual, and so on**
  - **constructing the transparency requires Enterprise knowledge**
- ***Federation is an ANSA research area***
  - **how it relates to trading**
  - **part of ANSA Phase III**

## Selective Transparency Engineering - Replication

- Replication Transparency
  - application need not know how many copies

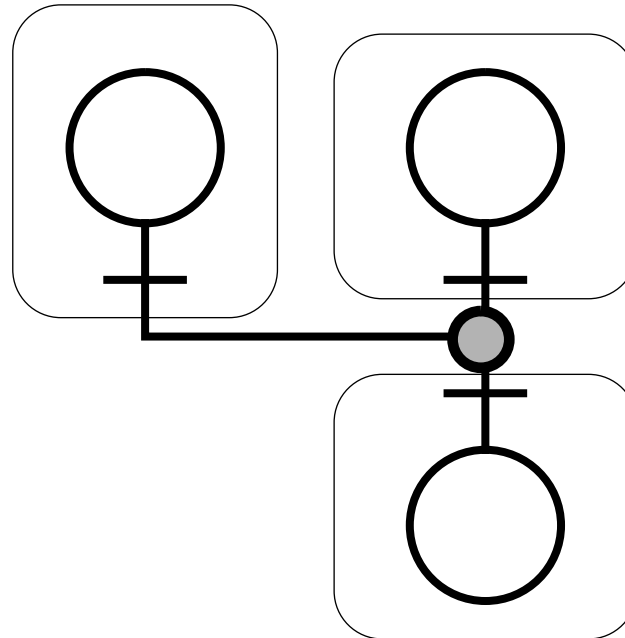

- application only sees a single interface



## Replication Transparency

- *Server objects are members of a group*
  - do not confuse with a cluster!
- *Replication transparency uses special mechanisms to make sure the group members are consistent*
  - for instance, it may use multi-point channels and special protocols
- *Implementing replication transparency efficiently is difficult*
  - it may need information from the application
  - it is under active research in the distributed systems community

## Selective Transparency Engineering - Failure

- Failure Transparency
  - application need not know when an object fails

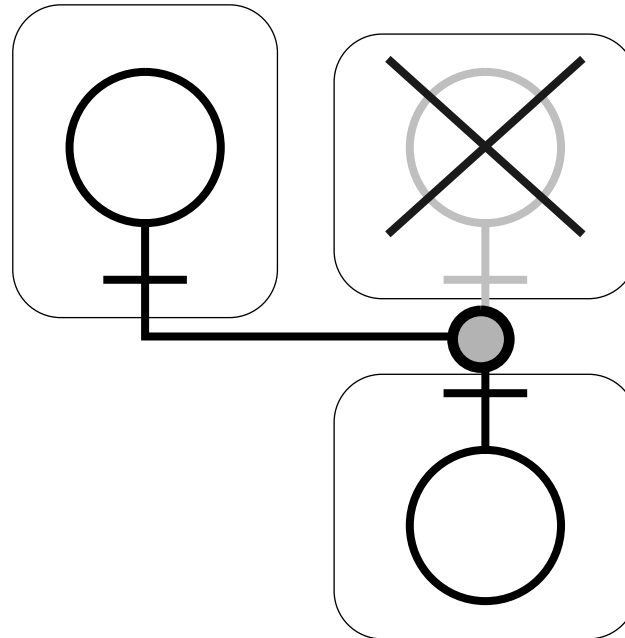

- may use replication transparency to achieve this



## Other transparencies

- ***Security***
  - application need not be aware of security policy
- ***Concurrency***
  - application need not be aware of other concurrent operations
- ***Transaction***
  - applications need not be aware of inconsistent states





---

## Computational and Engineering Models - comparison

- *Computational Model is for specifying interfaces for distribution*
  - interfaces consist of operations
  - operations have (multiple alternative) terminations
  - everything has a type
- *Engineering Model is the infrastructure for Computational Model*
  - encapsulation using capsules, clusters, and nodes
  - communication using channels
  - concurrency using threads
  - transparency mechanisms
- *The Computational Model is pure...*
- *... the Engineering Model supports trade-offs*



---

## Summary

- ***This has described the Engineering Model***
  - ANSAware implements some, but not all of the Engineering Model...
  - ... and not always as described in the Engineering Model
  
- ***For more information:***
  - on transparency mechanisms, see *The Challenge of ODP (TR.033.02)*
  - on replication transparency and groups, see *A Model for Interface Groups (AR.002.01)*
  - on federation, see *The ANSA Model for Trading and Federation (AR.005.00)*
  - on streams, see *Integrating Multimedia into the ANSA Architecture (TR.028.00)*